

Systems Reference Library

IBM 1311 Disk Storage Drive

This manual describes the operating principles and features of the IBM 1311 Disk Storage Drive and the IBM 1316 Disk Pack as they are used with all IBM Systems.

Included in the manual is a description of the operating keys and lights and of disk pack operating and handling procedures.

The information in this manual is intended to supplement the information contained in the system reference manuals for the following IBM Systems:

- 1240 Bank Data Processing System
- 1401 and 1460 Data Processing Systems
- 1410 and 7010 Data Processing Systems
- 1440 Data Processing System
- 1620 Data Processing System
- 1710 Control System
- 7740 Communication Control System

Information about addressing disk storage, programming considerations, and special features is contained in the respective system reference manuals.

This publication supersedes the following IBM publications:

IBM 1311 Disk Storage Drive A24-3086-3

IBM 1311 Disk Storage Drive, Model 3 A26-5650-3

Copies of this and other IBM publications can be obtained through IBM Branch Offices.
Comments concerning the contents of this publication may be addressed to:
IBM, Product Publications Department, San Jose, Calif. 95114

CONTENTS

1311 DISK STORAGE DRIVE	1	Rotational Time	5
Five Models of 1311	1	Data Transfer Time	5
Special Features	1	OPERATOR KEYS AND LIGHTS	7
Model 1	1	DISK PACK OPERATING AND HANDLING PROCEDURES ...	9
Model 2	1	Installing the Disk Pack	9
Model 3	2	Removing the Disk Pack	9
Model 4	2	Disk Pack Handling	9
Model 5	2	Disk Pack Labelling	9
Functional Description of the 1311	2	Receiving the Disk Pack	10
Disk Assembly	2	Storage Requirements	10
Access Mechanism	2	Machine Room Housekeeping	10
Disk Pack Organization and Capacity	3	Shipping Procedures	10
Sector Addresses	3	INDEX	11
Cylinder and Head Designation	4		
Timing Considerations	4		
Access Time	4		



25000

IBM 1311 Disk Storage Drive

The IBM 1311 Disk Storage Drive provides for random or sequential access storage of two million characters on-line at one time. One to four additional units (depending upon the system they are attached to) can be connected for a total on-line storage capacity of from eight to ten million character positions. In some systems a special feature (Track Record) provides up to an additional five million characters.

In addition, practically unlimited data storage is possible because a "disk pack" on each drive unit is easily removed and replaced with another pack. The 1316 Disk Pack (Figure 1) provides for interchangeable disk storage between all models of the 1311 Disk Storage Drive. Thus, the large storage capacity previously available only with magnetic tape, coupled with the unique advantage of random access, affords IBM Systems with greater flexibility in the handling of scientific, industrial, and commercial programs.

System programs, object programs, subroutines, and often-used table data can be stored in the same removable disk pack and a specific computation accomplished by mounting the pack and feeding the variable data into the system. This simplifies problem solving and increases the throughput of the system.

Removable disk packs offer an additional advantage in the security of classified information. Each pack can be stored in a safe or vault when it is not installed on a drive unit.

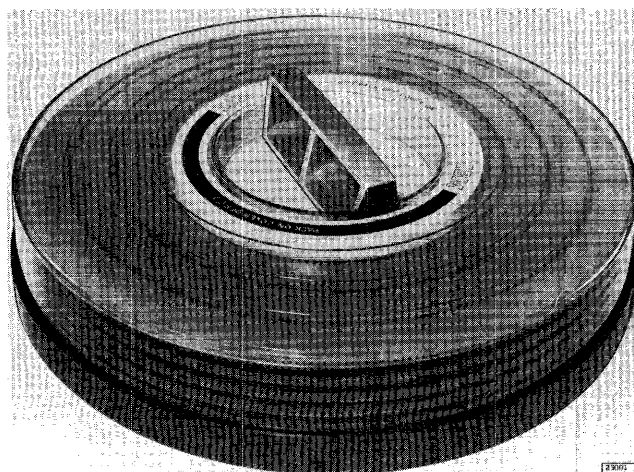

Figure 1. IBM 1316 Disk Pack

FIVE MODELS OF 1311

There are five models of the IBM 1311 Disk Storage Drive. Combinations of these models are used when more than one drive is attached to a system. Each system requires one drive as a master unit; additional units are known as satellite units. Models 1, 3, 4, and 5 are master units; Model 2 is always used as a satellite unit.

Special Features

Special features for the 1311 — which are listed below — are available for certain models only, as indicated in the model descriptions in the next section.

Direct Seek. This feature improves access time by moving the access mechanism directly to a specified location under program control.

Scan Disk. This feature provides an automatic rapid search of disk data for a specific identifier or condition.

Seek Overlap. This feature provides the flexibility to allow a seek operation to be overlapped with one 1311 read or write operation, plus any number of other seek operations.

Track Record. This feature allows for storing one 2,980 character record on each track. It increases disk pack capacity to 2,980,000 characters.

Model 1

The 1311, Model 1, is the required first drive when 1311s are attached to either an IBM 1440 or IBM 1460 Data Processing System, or to an IBM 1240 Bank Data Processing System. This model is the master drive on the system and contains controlling circuitry, and the lights and switches that control it and other 1311s attached to the system. One Model 1 and up to four additional Model 2 drives can be attached to a system.

Special Features. Direct Seek, Scan Disk, Seek Overlap, and Track Record.

Model 2

The 1311, Model 2, is used when more units than the master unit are required on the system. The Model 2 units are attached to a system through the master unit.

Special Features. Any special feature that can be installed on the master unit can be installed on the Model 2 satellite unit.

Model 3

The 1311, Model 3, is the required first drive when 1311s are attached to either an IBM 1620 Data Processing System or an IBM 1710 Control System. This model is the master drive on the system and contains power and controlling circuitry, and the lights and switches that control it and other 1311s attached to that system. One Model 3 and up to three additional Model 2 units can be attached to the system.

Special Features. None.

Model 4

The 1311, Model 4, is the required first drive when 1311s are attached to the IBM 1401 Data Processing System. This model is the master drive on the system and contains the power supplies, the controlling circuitry, and the lights and switches that control it and the other 1311s attached to that system. One Model 4 and up to four additional Model 2 units can be attached to the system.

Special Features. Direct Seek, Scan Disk, Seek Overlap, and Track Record.

Model 5

The 1311, Model 5, is the required first drive when 1311s are attached to an IBM 1410 or 7010 Data Processing System or to a 7740 Communication Control System. This model is the master drive on the system and contains the power supplies, the controlling circuitry, and the lights and switches that control it and other 1311s attached to the system. One Model 5 and up to four additional Model 2 units can be attached to a channel.

Special Features. Scan Disk, Seek Overlap, and Track Record. (Note: Direct Seek is a standard feature for the Model 5.)

FUNCTIONAL DESCRIPTION OF THE 1311

The IBM 1311 Disk Storage Drive is self-contained in a compact cabinet and consists of two major components: the disk assembly and the access mechanism.

Disk Assembly

The 1316 Disk Pack is a light, compact unit that weighs approximately 10 pounds. Each disk pack is composed of six disks, 14 inches in diameter, mounted 1/2 inch apart on a vertical shaft. Circular protective plates are mounted above the top disk and under the bottom disk to protect the assembly. The six disks provide ten surfaces on which data can be recorded. (The upper surface of the top disk and the lower surface of the bottom disk are not available because of the protective plates.) The entire assembly of disks, vertical shaft, and protective plates rotates at a speed of 1,500 revolutions per minute.

Access Mechanism

The access mechanism of the IBM 1311 has five horizontal access arms mounted on a vertical assembly and each arm is positioned between two disks as shown below.

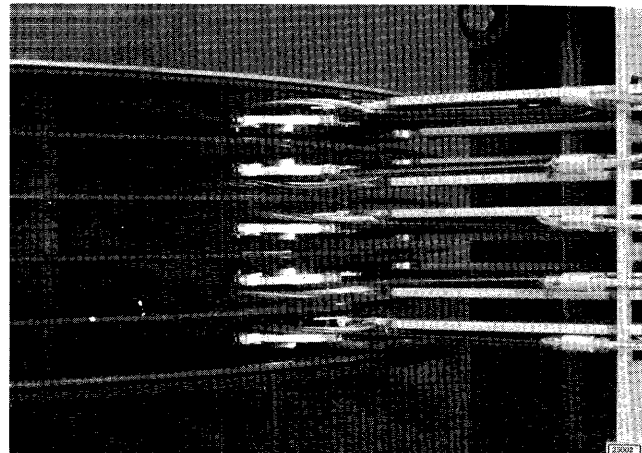

The whole assembly resembles a large comb. Each access arm has two read/write heads mounted at the extremity of the arm; each head is positioned to read or write on the corresponding upper or lower disk surface. The entire assembly moves horizontally from the "home" position — the position in which the read/write heads are near the periphery of the disks — toward the center so that the read/write heads will have access to the entire recording area.

Disk Pack Organization and Capacity

The access mechanism can be moved by an instruction to any one of 100 positions. Then, as the disks revolve, each of the ten read/write heads in turn can read or write information. The ten bands of information available to the read/write heads are called tracks. Together, the ten tracks can be likened to a "cylinder" of information. A single instruction can transfer all or any part of a cylinder to or from core storage. The concept of "cylinders" of information is illustrated in Figure 2.

For convenience in transferring data between core storage and disk storage, each of the 100 cylinders of data is divided into 200 sectors, 20 per track (Figure 3). The sector is the basic unit of data and contains 100 characters of data preceded by a 6-digit address. The addresses are sequential from sector to sector and from track to track. The sector addresses are verified, sector by sector, as the sectors specified in a read or write instruction are transferred from or to core storage.

The organization and capacity of the 1311 Disk Storage Drive may be summarized as follows:

One hundred character positions comprise a sector.

Twenty sectors (2,000 character positions) comprise one disk track.

Ten disk tracks (20,000 character positions) comprise a cylinder.

One hundred cylinders (2,000,000 character positions) are contained in a pack.

(The storage capacity can be increased to 2,980,000 characters if the Track Record feature is installed; Models 1, 2, 4, and 5.)

In the 1620 and 1710 Systems, one alphameric character is represented by numeric digits in two character positions. In all other systems alphameric characters require only one character position of the disk record.

Sector Addresses

Random-access disk storage is unique because it makes available each segment of data with equal facility; thereby making it unnecessary to pass a great many records to obtain the information required. In the 1311 Disk Storage Drive, each sector can be read or written individually or with a group of related sectors, as the occasion demands, depending on the number of sectors specified by the instruction.

The 6-digit sector address is sequential from 000000-019999, 020000-039999, 040000-059999,

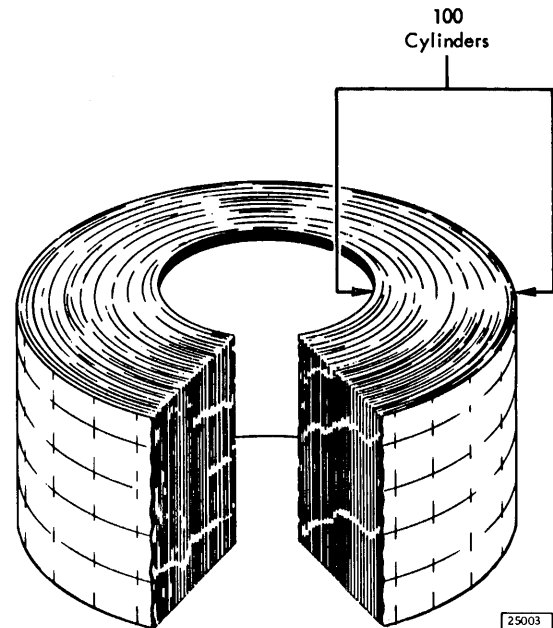

Figure 2. Cylinder Concept

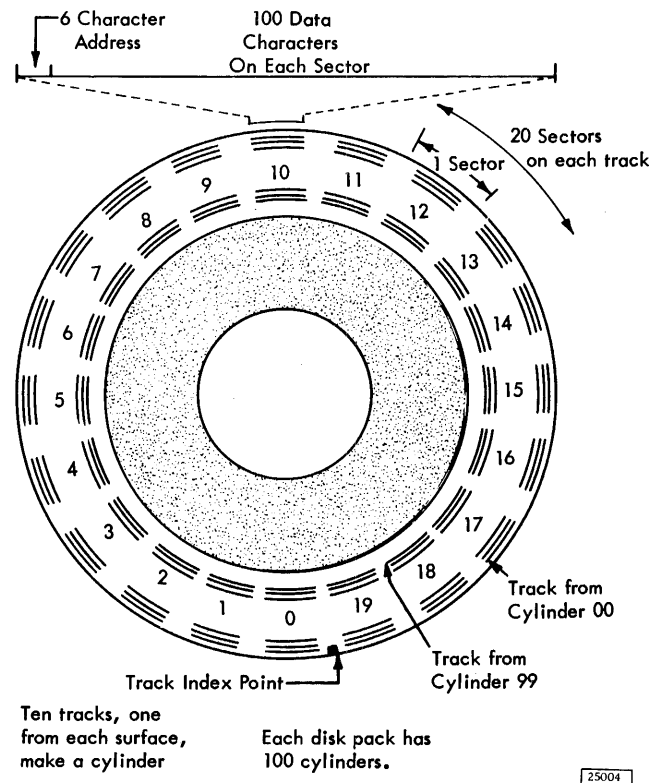

Figure 3. Arrangement of Data on a Disk

060000-079999, or 080000-099999 within each disk storage module. In the 000000-019999 sequence, sectors 000000-000019 are on the outermost track (cylinder 00) of the top recording surface (read/write head 0) (see Figure 4). Sectors 019980-019999 are on the innermost track (cylinder 99) of the bottom recording surface (read/write head 9). Using the sector address, the processing unit automatically selects the correct drive, cylinder, and read/write head.

The IBM 1316 Disk Pack is delivered from the manufacturing plant with pre-recorded sector addresses of 000000 through 019999.

NOTE: Six-digit sector addresses are provided in the 1311 Disk Storage Drive, although only five positions are required in some systems. The internal circuitry of the processing unit in these systems automatically supplies a high-order 0 (zero) to all addresses during seeking, reading, or writing operations; no additional programming effort is necessary.

Cylinder and Head Designation

In planning the organization of disk storage, and in computations where it is desirable to read or write the full 200 sectors in a cylinder, it may be necessary to know the cylinder and read/write head that is related to a given sector address. This can be accomplished in a simple subroutine by disregarding the first digit of the six-digit sector address and dividing the remaining digits of the address by twenty. The quotient is made up of the drive, cylinder, and track numbers; the remainder is the sector number. This operation is illustrated in Figure 5.

TIMING CONSIDERATIONS

Timing estimates for disk storage operations are dependent upon three factors: access time, rotational time, and the time required to transfer the data between core storage and disk storage.

Access Time

The access time is the time required to "seek" the record, that is, to position the read/write heads over the proper cylinder in the disk pack. When a seek instruction is executed, the read/write heads move from their present position to the "home" position and then move to the disk cylinder specified by the seek instruction.

Figure 6 shows actual seek times for cylinder-to-cylinder movement in increments of ten cylinders.

The minimum seek time — from cylinder 00 to cylinder 00 — is 75 ms; the maximum seek time — from cylinder 99 to cylinder 99 — is 392 ms. If the data on a disk pack is located completely in a random sequence throughout all 100 cylinders and the disk addresses

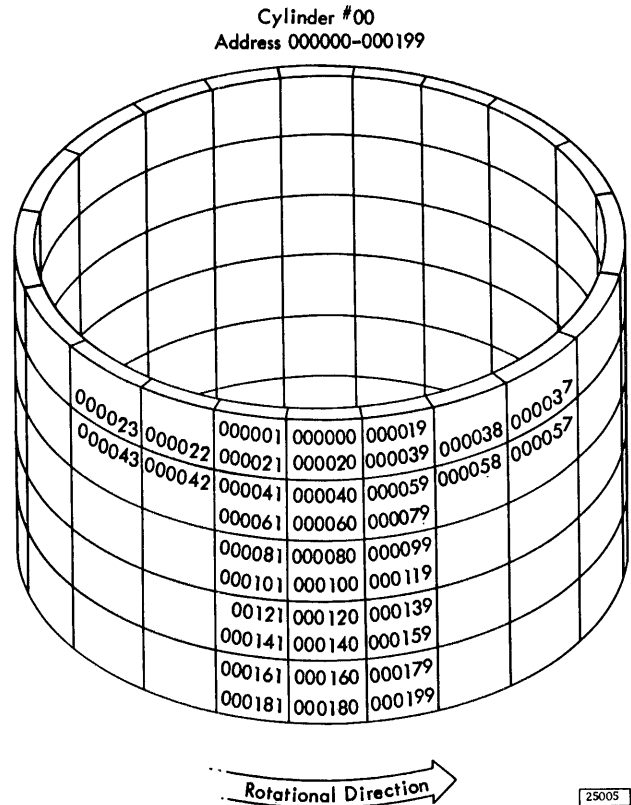

Figure 4. Addressing for Cylinder 00

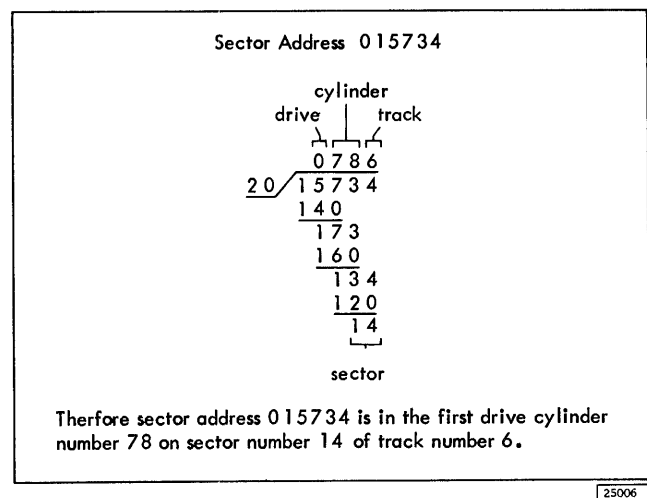

Figure 5. Physical Location of Sector Address

specified by the seek instructions are in a random sequence, then the average seek time is 250 ms.

In some applications, specific kinds of data may be located within particular ranges of cylinders. For example, inventory records may be located within cylinders 00-19 and tooling records within cylinders 20-39. When estimating times for applications such as these, the average access time should be based upon the seek times within the specific range of cylinders actually used, as shown in Figure 7.

Speed of Access Arm Movement

Another factor to be considered in systems planning is that the access arms move at both a low speed and a high speed. Access-arm movement within ten cylinders is at a low-speed rate of 2 inches per second. If more than ten cylinders are searched, the access arms move at the high-speed rate of 16 inches per second for all cylinders in excess of ten. These two speeds (2 inches and 16 inches per second) are not used by the programmer in timing disk storage operations because timing charts incorporate these variations in speed. Variation in speed is covered here so it can be considered when data is being organized in disk storage.

Dummy Seek to Cylinder 00

After a seek instruction has been issued, processing can continue until another disk-storage instruction is issued. The length of the seek depends on the total number of cylinders that must be passed during the seek operation. The total throughput time can be reduced by using a technique known as dummy seek to cylinder 00.

With this technique, the return-to-home portion of access time can normally be overlapped if a seek to cylinder 00 is issued before a card read or punch operation or a print operation.

Increased Speed with Special Features

The access and throughput time can be decreased if the features Direct Seek and Seek Overlap are installed on the system. The functions of these features are described in the reference manuals for the systems that can contain these features.

Rotational Time

Rotational time is the time required for the sector address specified in the instruction to reach the read/write heads after the read instruction has been initiated. Since there is no way of predicting the relative

positions of the disk sector addressed and the read/write head at the time the instruction is executed, rotational time is based upon an arithmetic average of the minimum and maximum rotational times.

There is a 2 ms delay, known as head select-delay, required for the selection of the appropriate read/write head. After this time, the sector addressed could be read if it were the next sector about to pass under the read/write head; therefore the minimum rotational time would be 2 ms. If, during the head select-delay time, the sector addressed is passing

TO	FROM										
	00	09	19	29	39	49	59	69	79	89	99
00	75	88	101	114	127	140	153	167	179	192	204
09	175	188	201	214	227	240	253	267	279	292	304
19	143	156	169	182	195	208	221	235	247	260	272
29	153	166	179	192	205	218	231	245	257	270	282
39	168	181	194	207	220	233	246	260	272	285	297
49	184	197	210	223	236	249	262	276	288	301	313
59	200	213	226	239	252	265	278	292	304	317	329
69	215	228	241	254	267	280	293	307	319	332	344
79	232	245	258	271	284	297	310	324	336	349	361
89	248	261	274	287	300	313	326	340	352	365	377
99	263	276	289	302	315	328	345	355	367	380	392

25007

Figure 6. Cylinder Seek Time

Cylinder Used	Average Seek Time
0 - 9	132 ms
0 - 19	144 ms
0 - 29	156 ms
0 - 39	169 ms
0 - 49	182 ms
0 - 59	198 ms
0 - 69	210 ms
0 - 79	224 ms
0 - 89	238 ms
0 - 99	250 ms

25008

Figure 7. Average Seek Time

under the read/write head, then a complete rotation would be required before the sector address could be read or written. Therefore, the maximum rotational time would be 42 ms; 40 ms for one rotation and 2 ms head select-delay. The average of these two times, 22 ms, is used for estimating rotational time.

Data Transfer Time

The data transfer time for a read, write, or check

disk operation is 2 ms for each sector processed.

When estimating the time for an instruction, only the rotational time and the time required to transfer the data are used. The time required to execute the instruction in the processing unit is usually ignored because of the wide disparity in the units of measurements — milliseconds to microseconds — and also because the millisecond values are only average times.

The operating keys and lights for the Models 1, 3, 4, and 5 and for Model 2 are shown in Figure 8.

Module Light

This dual-purpose light identifies the drive and indicates that the unit is on and ready to function as directed by disk instructions. If the unit is addressed without the Module light being on, the processing unit interlocks.

Compare-Disable Switch (Master Unit Only)

This switch is operated by using a key which can be removed only when the switch is rotated counterclockwise to the OFF (normal) position. When the Compare-Disable switch is ON and the Write Address key is pressed, a full track write operation may be accomplished without the necessity of comparing addresses. This allows writing a full track, if addresses have been destroyed or if the track is empty.

Select Lock Light (Master Unit Only)

Various internal test circuits are included in the master unit to test the operation of all disk drives

attached to the system. A failure at any one of the monitored test points stops the operation of all disk storage drives attached to the system and turns on the Select Lock light. If the Select Lock light is on, the system requires service by an IBM Customer Engineer.

Write-Address Key Light (Master Unit Only)

Pressing this key allows sector addresses and data to be written in disk storage. When the key is pressed to enable a write disk track operation, the processing unit interlocks if a write disk operation other than a write disk track is attempted. Pressing the key a second time terminates the enabling condition.

Enable-Disable Switch (Meter)

Positioning this switch on a 1311 master drive to ENABLE permits the CPU to use the master drive. This switch position also activates the 1311 meter if the CPU meter is operating. If the position of the switch is changed while the CPU is running, the operating status of the 1311 is not affected until the CPU has been stopped by a programmed halt. If one or more satellite drives is installed, it is interlocked with the

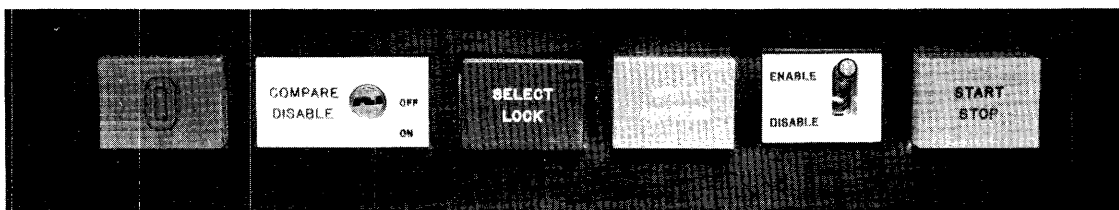

Models 1, 3, 4, and 5

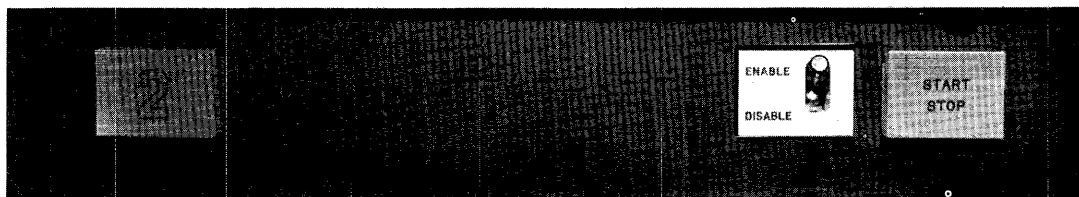

Model 2

25009

Figure 8. 1311 Operating Keys, Lights and Switches

master drive so that its use by the CPU cannot be accomplished unless the Enable-Disable switches on both master drive and satellite drive, are in the ENABLE position.

While a disk pack is being changed in the master drive, the meter stops if no satellite drive is being used by the CPU. If a disk pack is changed in a satellite drive, the affected drive meter stops; however, the master drive meter continues to run, if another drive in the system is still in use.

Start Stop Key Light

This key on each disk storage drive starts and stops the disk drive motor. The key must be turned off to stop the motor and retract the access mechanism before the disk pack can be removed. Therefore, a seek instruction must precede a read or write instruction after the motor has been turned off and then on again.

Installing the Disk Pack

The disk pack should always be carried by the built-in handle on the top of the cover. A self-locking device in the handle permits removal of the top cover only when the disk pack is mounted on the disk storage drive.

Loading

1. Make certain power has been turned on.
2. Open the disk storage drive cover.
3. Remove the bottom cover from the disk pack using the bottom cover knob.
4. Place the disk pack on the spindle.
5. Turn the top cover in a clockwise direction (as indicated by the ON arrows) until it comes to a full stop. Even though the cover might become disengaged before the full stop point is reached, the cover should continue to be turned to insure the activation of the "pack on" safety switch. This switch must be activated before the 1311 can be started.
6. The top cover can then be removed, leaving the disk pack locked on the spindle. Never leave the top cover inside the disk drive.
7. While the disk pack is on the drive, the top and bottom covers should be reassembled and stored in a designated storage area.

Removing the Disk Pack

Unloading

1. Make certain power has been turned on.
2. If the drive has been in use, press the Stop key.
3. Wait for the disk pack to come to a complete stop before opening the cover of the drive unit.
4. Open the disk drive cover.
5. Replace the top cover over the top of the pack and engage the cover pins.
6. Turn the cover in a counterclockwise direction (as indicated by the OFF arrow) for two full turns. The cover has then been securely fastened to the disk pack so that both the pack and the top cover can be removed from the spindle of the 1311 as a unit.
7. The bottom cover must then be immediately attached to create a positive dust seal.

Disk Pack Handling

For protection against dust, the cover of the drive must always be kept closed, whether a disk pack is installed or not.

If the disk pack receives a sharp impact, for example, by falling from a shelf or table or by being dropped, it must not be placed on a disk storage drive until it has been inspected by an IBM Customer Engineer; if it is damaged and it is mounted on the drive, it can further damage the pack and the machine.

The disk pack assembly is specifically designed to prevent removal of the cover when the pack is not on the disk storage drive. The disk pack should never be handled without its cover.

Care must be exercised in installing the disk pack. If the hub of the disk storage drive receives a sharp impact from the disk pack, the contour of the hub and/or the pack drum can be altered and cause misalignment of the disk surfaces to the read/write heads. Objects should not be placed between the disks or where they can fall on or be pushed against the disk surfaces.

Disk packs that contain useful information must never be exposed to an intense magnetic field. (Technically, an intensity greater than 50 oersteds may cause loss of information. The IBM Physical Planning Engineer may be consulted if high-intensity fields are suspected.)

Smoking should be avoided while handling a disk pack. Ashes can contaminate the disks. It is also recommended that smoking be prohibited in the computer room.

Disk Pack Labelling

Labels should be placed on the center hub of the disk pack. The transparent cover enables the disk pack label to be read with the cover on. Labelling the disk pack only, precludes the possibility of placing a labeled cover on the wrong pack, which could result in the altering or loss of pertinent data.

Disk packs should be labeled with a material that can be removed without leaving a residue. Adhesive stickers that can be applied and removed easily are satisfactory. Write on the label before it is applied. Use a writing implement that does not produce loose residue, for example, a pen or felt-tip marker — never a lead pencil.

Never use an eraser to alter the identification on a label. Erasing creates foreign particles that can interfere with the proper spacing between the read/

write heads and the disks. These foreign particles may be too small to detect with the human eye.

Use a new label if changes are necessary.

Receiving the Disk Pack

The disk pack is shipped in a container that can withstand normal freight handling abuse. However, if the container shows shipping damage, an IBM Customer Engineer should be consulted prior to using the disk pack on the 1311 Disk Storage Drive. By so doing, the possibility of damage to the drive and the disk pack can be eliminated.

Storage Requirements

Disk packs should be stored in the data processing room in enclosed metal cabinets or fire-resistant containers that are elevated from the floor and protected from sources of dust and dirt such as paper, cards, etc. This precaution minimizes transfer of dust to the disk storage drive during loading operations and also provides additional protection in case of fire.

A separate room can be used to store duplicate master records or other vital data. If such a room is used, it should be constructed of fire-resistant material and contain appropriate fire prevention equipment.

The ideal environment for storage of disk packs is the same environment as the computer room (60°-90°, 10%-80%). If the pack is removed from this environment it should be conditioned to the operating environment for two hours. The time is required to assure correct track registration and data recording and retrieval.

Disk packs should never be stored in direct sunlight, stacked one on top of another, or stored on edge.

Like many other modern high-quality plastics, the cover of the disk pack may ignite if it is exposed to continuous intense heat. The ignition point is 475° Fahrenheit, and if the cover burns it will release carbon monoxide gas, chlorine compounds, and intense smoke.

Machine Room Housekeeping

The read/write heads of the 1311 Disk Storage Drive "float" over the surfaces of the disk pack on a thin "film" of air molecules - a film so thin, that it is measured in millionths of an inch. Some types of

dust or dirt on the disk surfaces can cause permanent damage to the disk surface and the read/write heads. Precaution should be exercised to prevent foreign particles from entering the 1311 while disk packs are being placed on or removed from the system; therefore, dirt or dust should be kept to a minimum in the environment of the machine room.

Good housekeeping practices should always prevail in the machine room. It should receive daily attention with a vacuum, wet mop, or similar device. Use of cleaning implements that raise dust such as brooms and feather dusters should be avoided. Steel wool or metal abrasives should never be used for buffing the floor. Waxes or other top dressings which may flake should be lightly applied, if used at all.

Shipping Procedures

When a disk pack is being shipped from one location to another location, certain precautions should be followed:

1. The pack must be tightly secured in its two-piece cover. This cover presents a positive dust seal and thereby eliminates the need for a plastic bag around the pack.
2. In order to properly protect the disk pack from shock, it should be shipped or transported in the IBM shipping container, surrounded by approximately 2" of wadding material, in a larger corrugated box. If desired, the customer can obtain a special-designed double-container through the local IBM office. Any questions regarding packaging of the disk pack for shipment can be answered by the local IBM representative.
3. If, after a disk pack has been received, the shipping container shows damage, an IBM Customer Engineer should be consulted prior to using the disk pack.
4. When a disk pack is removed from a container, it should be dusted before it is taken into the machine room for its conditioning period.

The 1311 Disk Storage Drive was designed so that the removable packs would be transportable. If the above suggestions are followed and reasonable care is used in handling, shipping the disk pack should not present any unusual hazards in data processing. No warranty of safety of data or pack, however, is expressed or implied by IBM.

INDEX

Access Mechanism	2	Installing the Disk Pack	9
Access Time	4	Labelling the Disk Pack	9
Addressing	3	Loading the Disk Pack	9
Arm Movement	5	Machine Room Housekeeping	10
Arrangement of Data on a Disk (Figure 3).	3	Model Descriptions	1, 2
Average Seek Times	5	Receiving the Disk Pack	10
Compare-Disable Switch	7	Removing the Disk Pack	9
Cylinder and Head Designation	4	Rotational Time	5
Cylinder Concept	3	Sector Addresses	3
Cylinder Seek Time	5	Select Lock Light	7
Data Transfer Time	6	Shipping Procedures	10
Disk Assembly	2	Special Features	1
Disk Pack	2	Start Stop Key Light	8
Dummy Seek	5	Storage Requirements	10
Enable-Disable Switch	7	Timing Considerations	4
Functional Description	2	Unloading the Disk Pack	9
Handling the Disk Pack	9	Write-Address Key Light	7
Head and Cylinder Designation	4		
Home Position	2		



International Business Machines Corporation
Data Processing Division
112 East Post Road, White Plains, N. Y. 10601